

MS6

3.7-30 kW



- Ⓜ **GB** Bearing retainer
- Ⓜ **D** Lagerhalter
- Ⓜ **F** Retenue palier
- Ⓜ **I** Fermo cuscinetto
- Ⓜ **E** Sujeción del cojinete
- Ⓜ **P** Retentor do casquilho
- Ⓜ **GR** Φωλιά εδράνου
- Ⓜ **NL** Lagerhuis
- Ⓜ **S** Lagerhållare
- Ⓜ **FIN** Laakerinpidin
- Ⓜ **DK** Lejeholder
- Ⓜ **RU** Сепаратор подшипника





**Warning:** In order to ensure correct assembly when using a lubricant, parts must be assembled and tightened while the lubricant is still wet.

**Warnung:** Um bei Verwendung eines Schmiermittels eine korrekte Montage zu gewährleisten, müssen die Bauteile zusammengebaut und befestigt werden, solange das Schmiermittel noch nicht getrocknet ist.

**Avertissement:** Afin d'assurer un montage correct en utilisant un lubrifiant, les pièces doivent être montées et serrées avant que le lubrifiant ne se solidifie

**Avvertimento:** Per assicurare un corretto assemblaggio, occorre assemblare e serrare le parti mentre il lubrificante è ancora umido.

**Aviso:** Para asegurar el correcto montaje cuando se utiliza un lubricante, las partes deben ensamblarse y apretarse cuando el lubricante está todavía humedo.

**Aviso:** Com o objectivo de assegurar uma correcta montagem quando utilizar um lubrificante, as peças devem ser montadas e apertadas enquanto o lubrificante ainda está molhado.

**Προειδοποίηση:** Για να εξασφαλιστεί σωστή συναρμολόγηση όταν χρησιμοποιείται λιπαντικό, τα εξαρτήματα θα πρέπει να συναρμολογηθούν και να σφικτούν ενώ το λιπαντικό είναι ακόμα υγρό.

**Waarschuwing:** Om bij het gebruik van een smeermiddel te zorgen voor een correcte montage, moeten de onderdelen worden gemonteerd en aangedraaid wanneer het smeermiddel nog nat is.

**Varning:** För att säkerställa korrekt montering vid användning av ett smörjmedel måste delar monteras och dras åt när smörjmedlet är nyapplicerat.

**Varoitus:** Oikean asennuksen varmistamiseksi voiteluainetta käytettäessä, osat tulee koota ja kiristää voiteluaineen ollessa vielä märkää.

**Advarsel:** For at sikre korrekt sammenspænding ved anvendelse af smøremidler, skal delene spændes sammen, mens smøremidlerne stadig er våde.

**Внимание:** Для того чтобы обеспечить правильную сборку при использовании смазочного материала, детали необходимо собрать и затянуть, пока смазка ещё жидкая.

3.7-9.2 kW .....	4
11-30 kW .....	16

## 3.7 - 9.2 kW

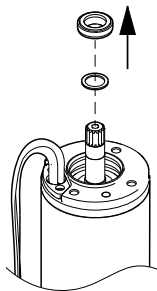
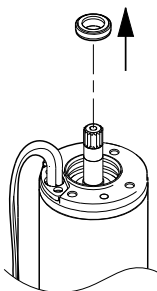
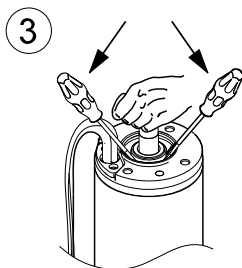
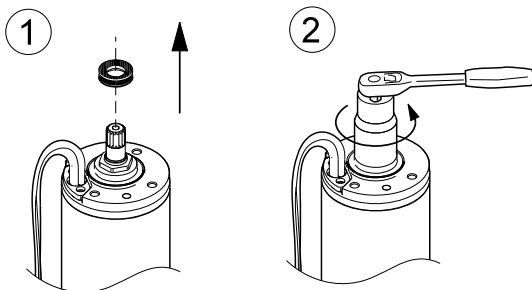

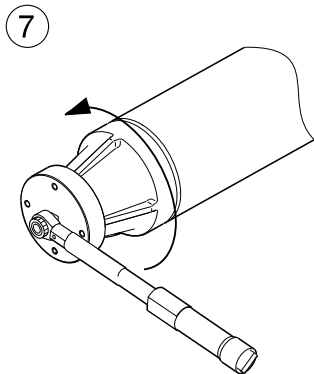
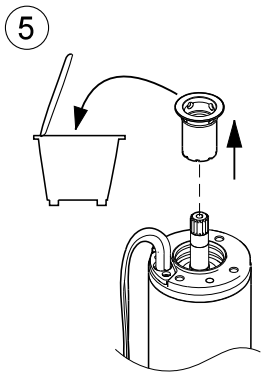

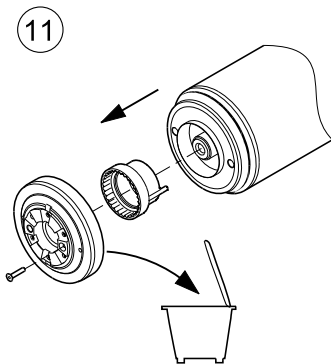
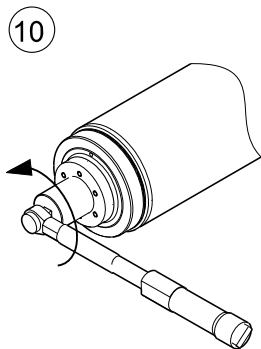
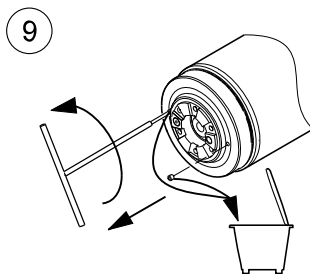
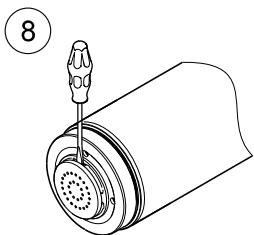

12

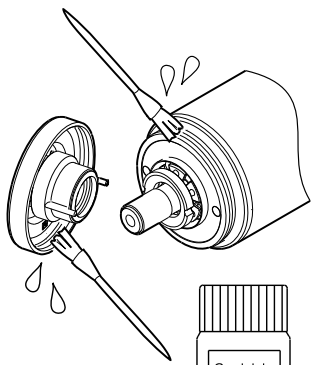

13

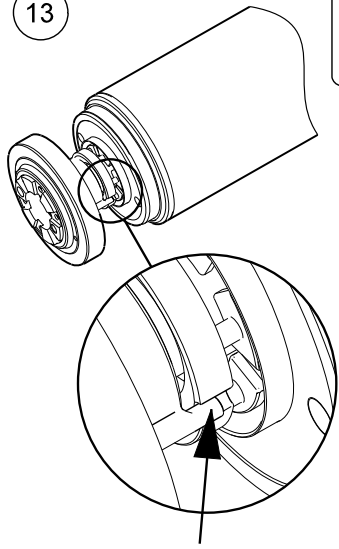

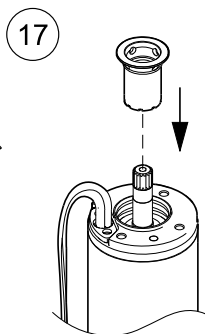
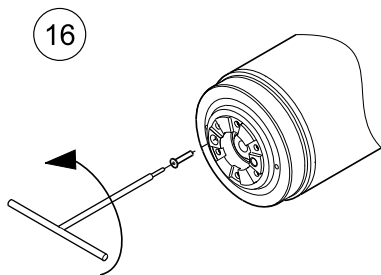
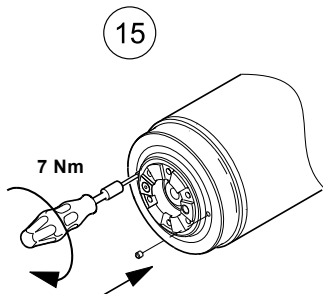
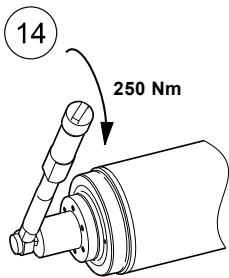



18

72.8 ±0.2

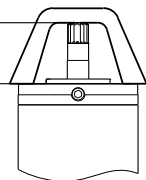

72.8 ±0.2

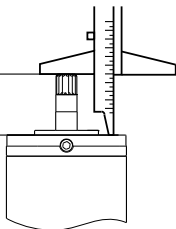

72.8 ±0.2 mm ✓ → 21

72.8 ±0.2 mm ✗ → 19

19

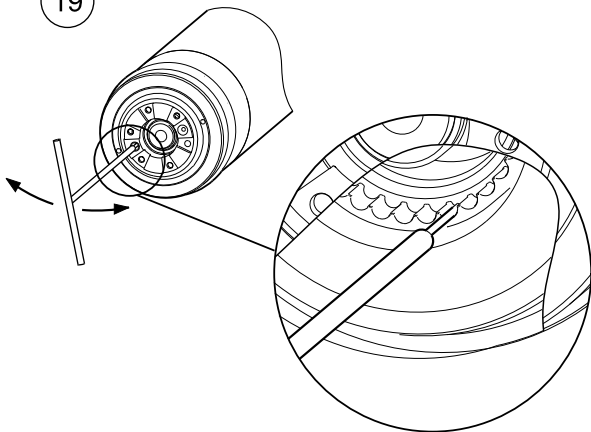

20

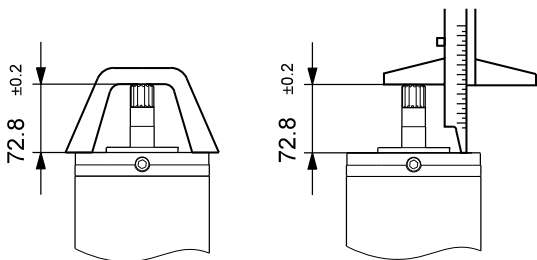

$72.8 \pm 0.2$  mm ✓ → 21

$72.8 \pm 0.2$  mm ✗ → 19

21

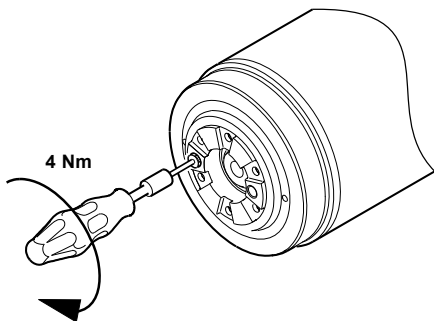

22

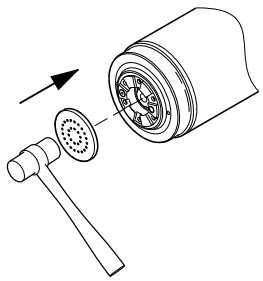

23

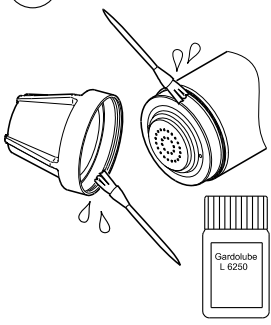

24

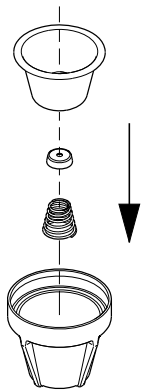

25

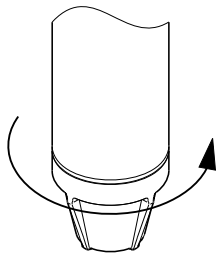

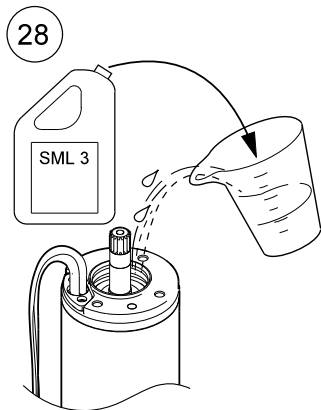
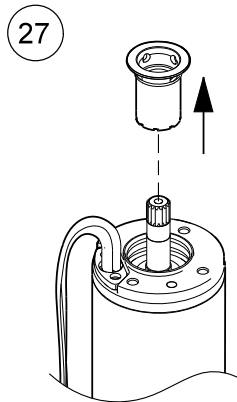
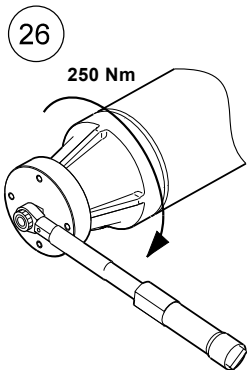

29

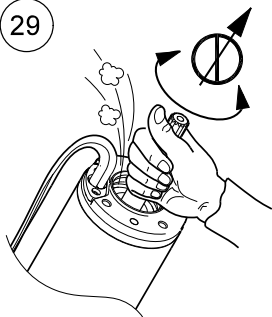

30

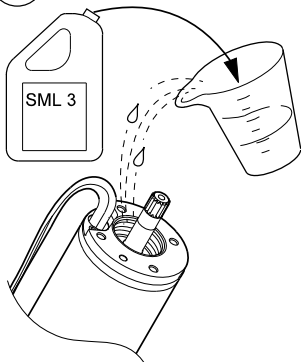

31

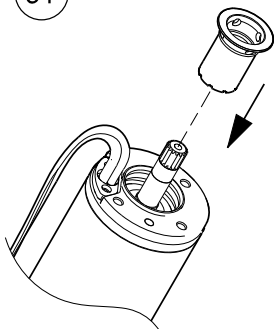

32

MODEL A

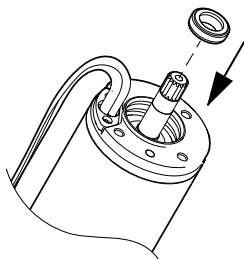

33

MODEL B

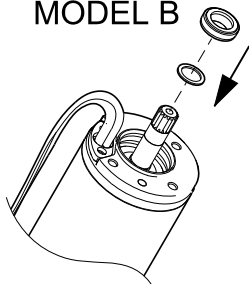

34

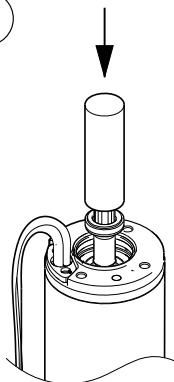

35

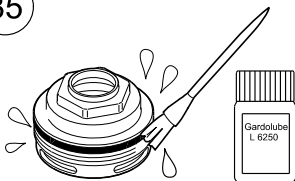

36

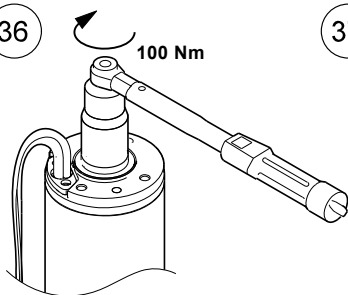

37

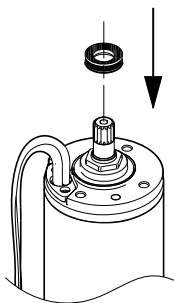

38

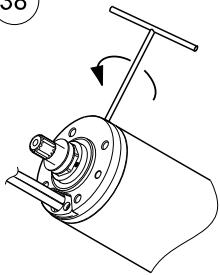

39

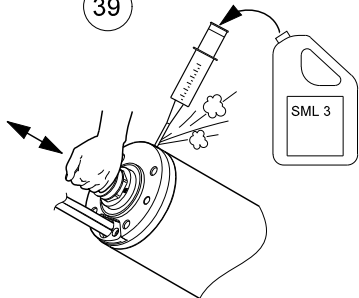

40

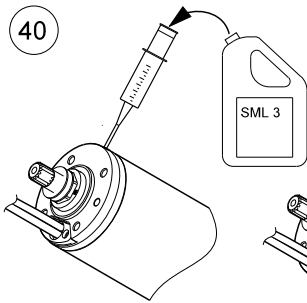

41

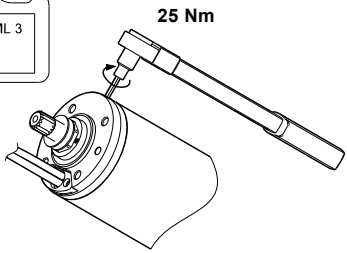

# 11-30 kW

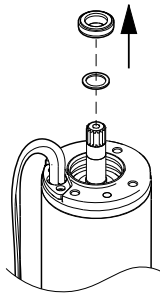
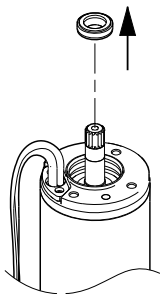
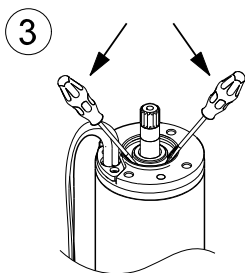
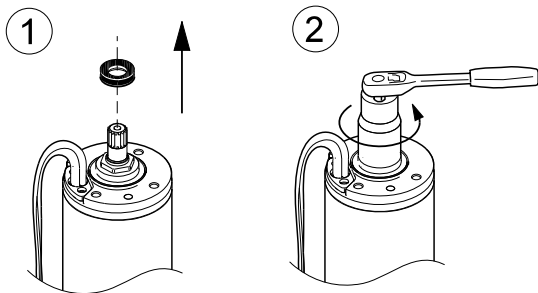



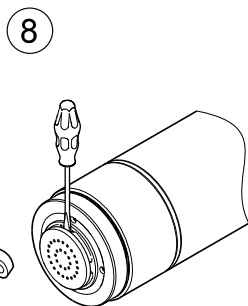
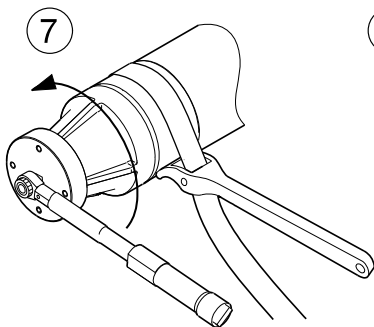
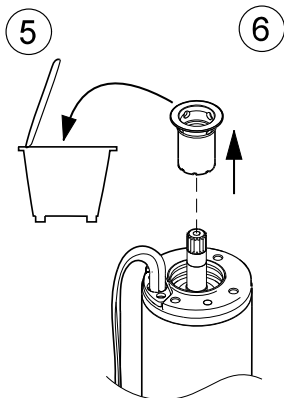

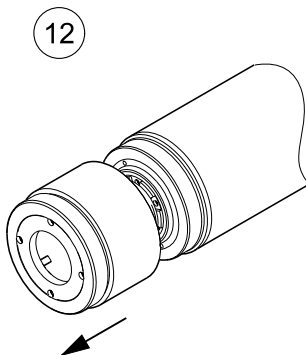
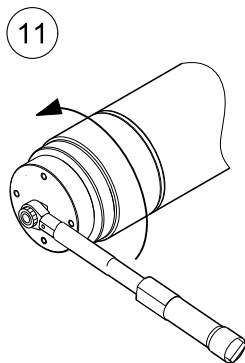
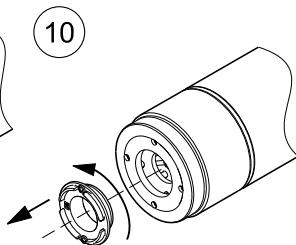
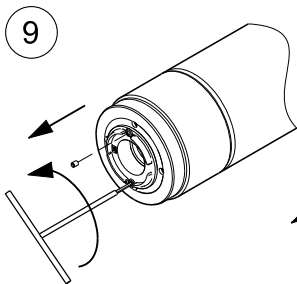

13

Model A

Model B

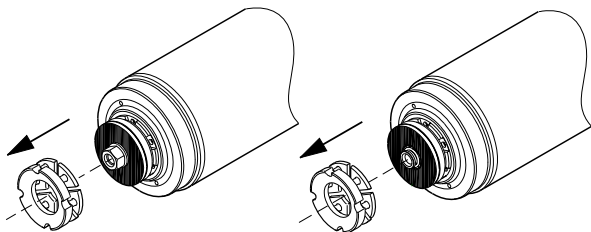

14

Model A

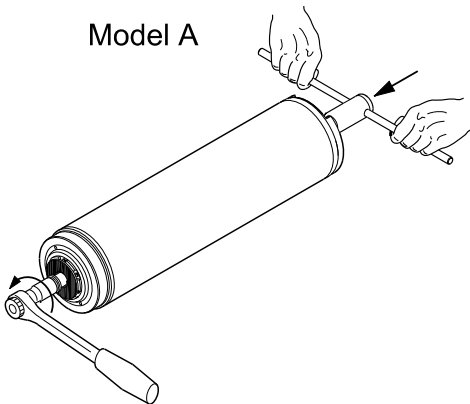



## Model A



MS6REST30		No. 78195650		Model: A		SN: 10000001		PC P20639	
Phase	Voltage	Frequency	P <sub>2</sub>	P <sub>2</sub>	SF	Max. SF. C.	Cos φ	n	
[ ]	[V]	[Hz]	[kW]	[hp]	[ ]	[A]	[ ]	[min <sup>-1</sup> ]	
3	380	50	30		1.00	67.0	0.88	2840	
3	400	50	30		1.00	65.0	0.84	2870	
3	415	50	30		1.00	65.5	0.80	2880	

Liquid t<sub>max</sub> 30°C at 0.15 m/s / °F at 0.5 ft/s Connection D Weight: 78 kg/ lb  
 Duty S1 ~~Transmitter temp.~~ p<sub>max</sub> 60 bar IP 68 Ins.cl. F  
 MADE IN HUNGARY

CE  US

**GRUNDFOS**® 

15

## Model B



MS6REST30		No. 78195650		Model: B		SN: 10000001		PC P20639	
Phase	Voltage	Frequency	P <sub>2</sub>	P <sub>2</sub>	SF	Max. SF. C.	Cos φ	n	
[ ]	[V]	[Hz]	[kW]	[hp]	[ ]	[A]	[ ]	[min <sup>-1</sup> ]	
3	380	50	30		1.00	67.0	0.88	2840	
3	400	50	30		1.00	65.0	0.84	2870	
3	415	50	30		1.00	65.5	0.80	2880	

Liquid t<sub>max</sub> 30°C at 0.15 m/s / °F at 0.5 ft/s Connection D Weight: 78 kg/ lb  
 Duty S1 ~~Transmitter temp.~~ p<sub>max</sub> 60 bar IP 68 Ins.cl. F  
 MADE IN HUNGARY

CE  US

**GRUNDFOS**® 

31

15

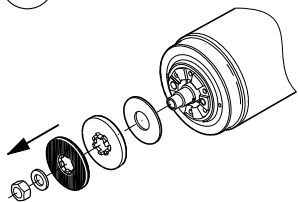

16

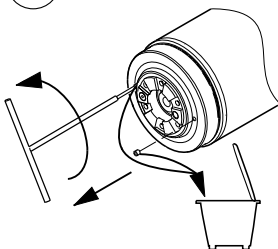

17

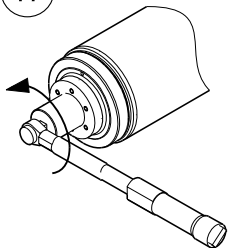

18

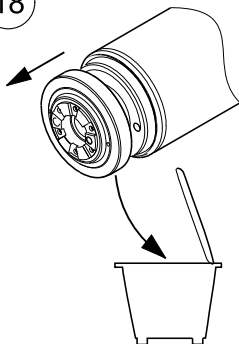

19

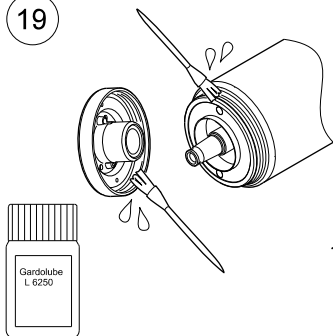

20

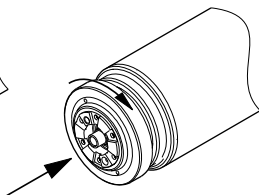

21

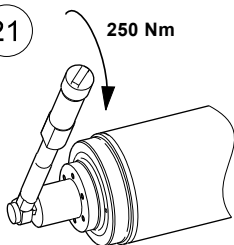

22

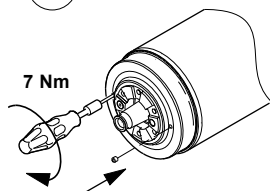

23

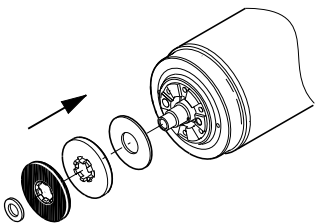

24

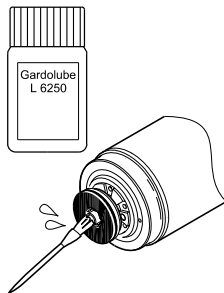

25

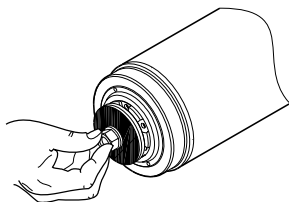

26

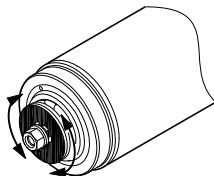

27

110 Nm

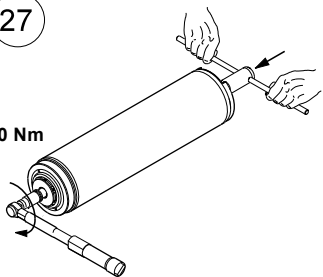

28

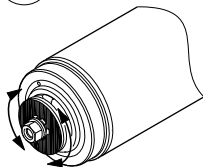

29



30

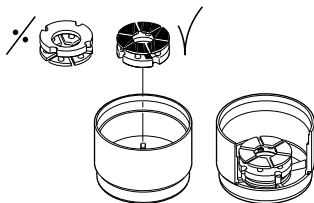

30 ✓ → 44



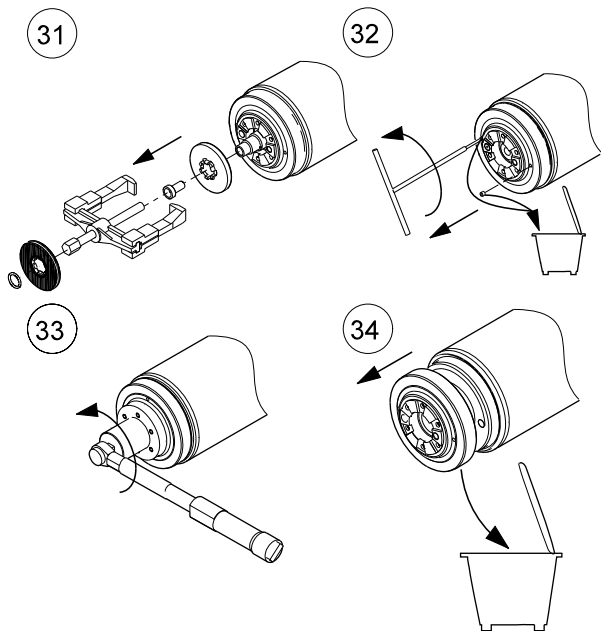

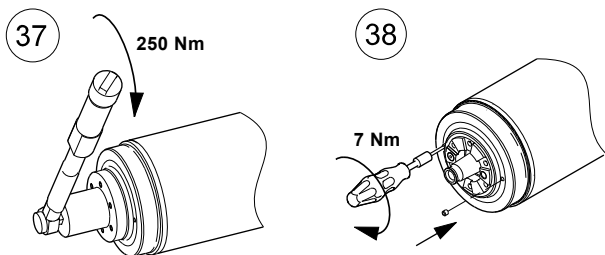
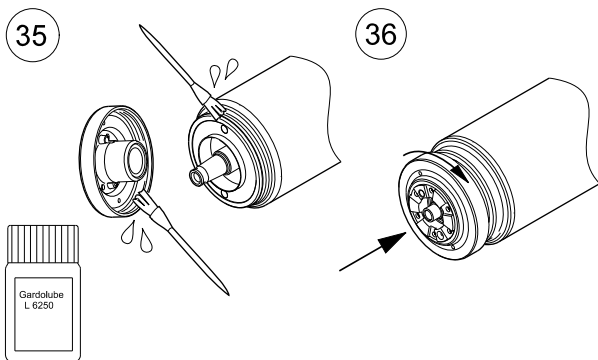

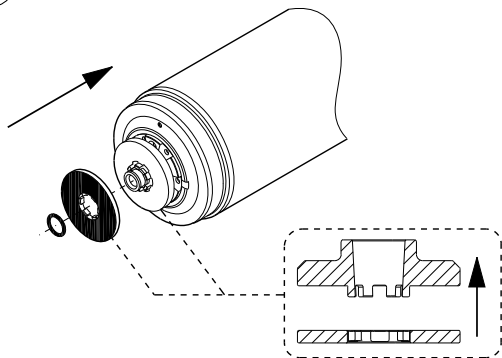
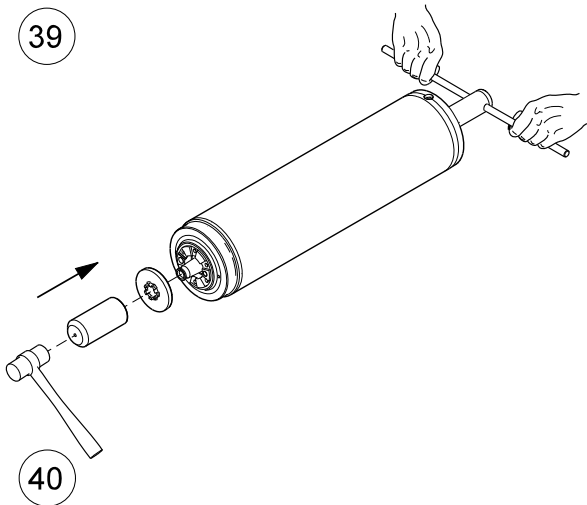

41

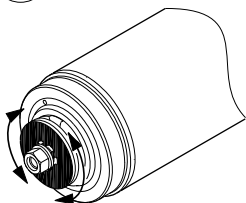

42

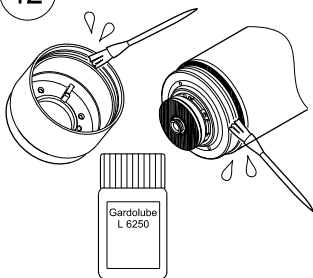

43

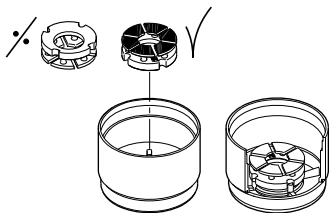

43 ✓ → 44

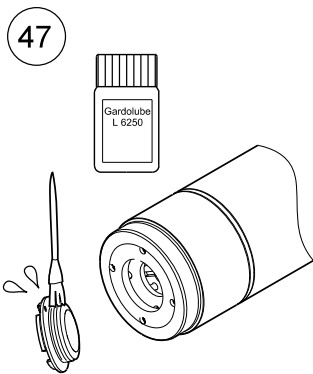
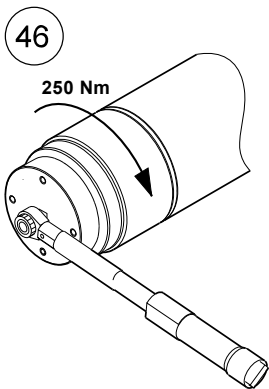
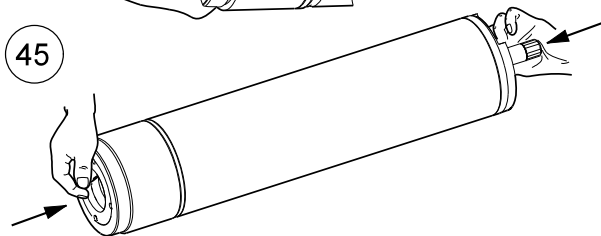
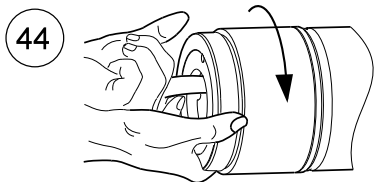

48

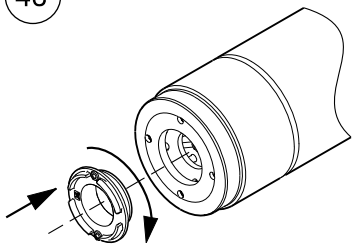

49

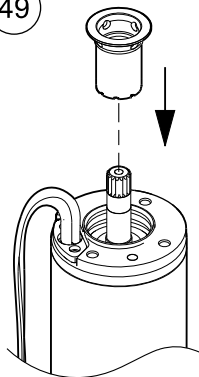

50

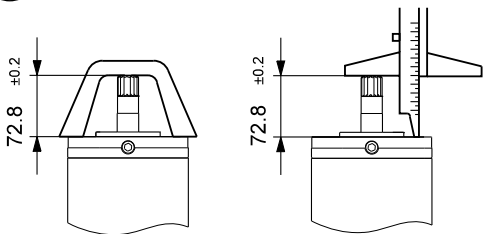

72.8 ±0.2 mm ✓ → 53

72.8 ±0.2 mm % → 51

51

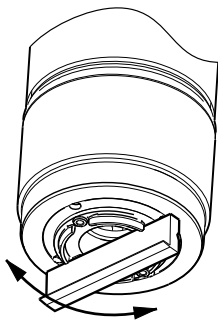

52

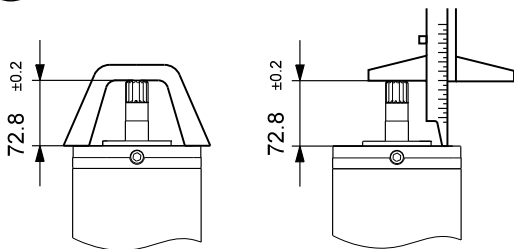

$72.8 \pm 0.2$  mm  $\checkmark$  → (53)

$72.8 \pm 0.2$  mm  $\%$  → (51)

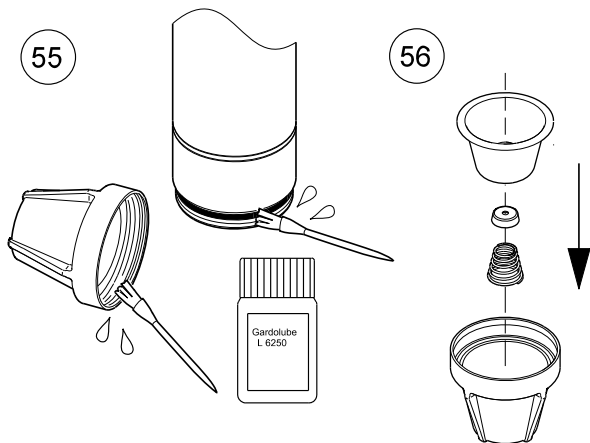
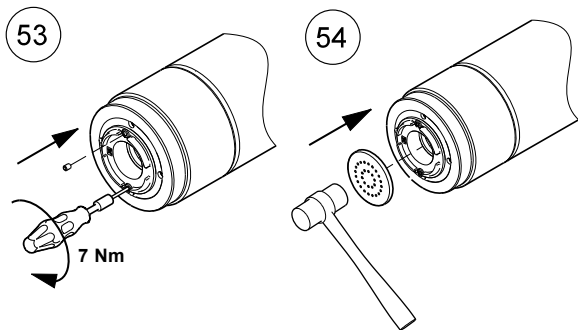



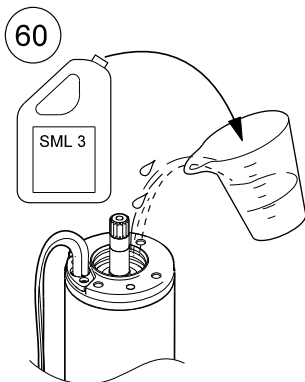
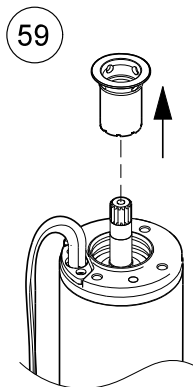
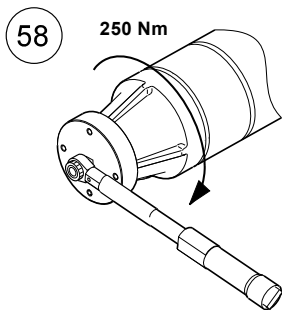
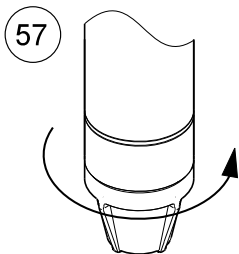

61

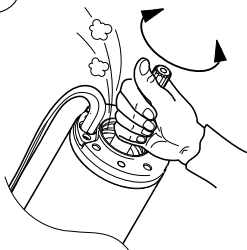

62

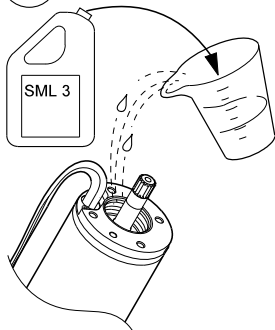

63

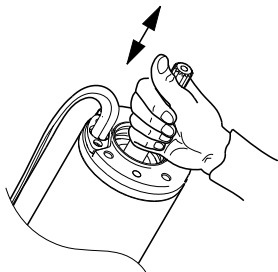

64

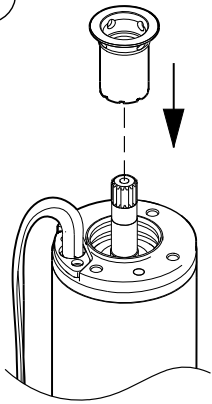

65

Model A

Model B

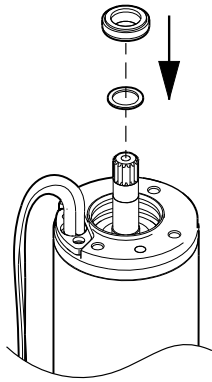
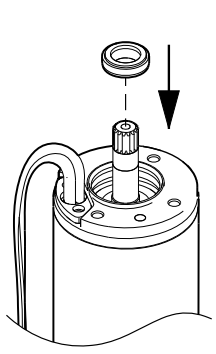

66

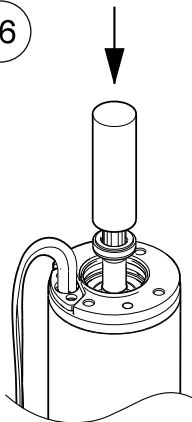

67

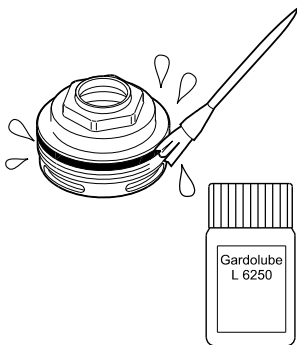

68

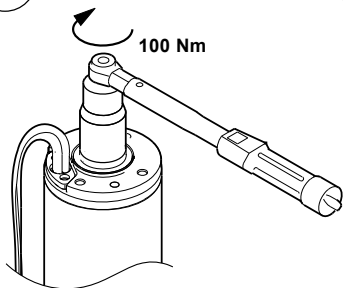

69

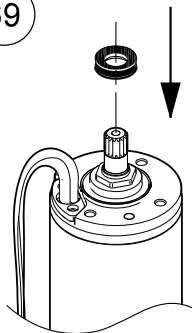

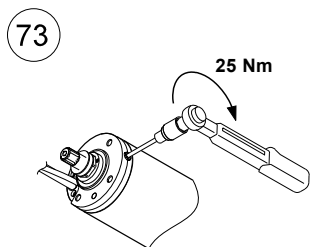
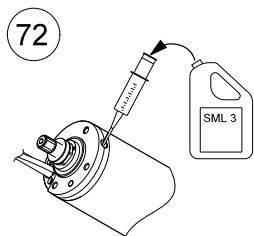
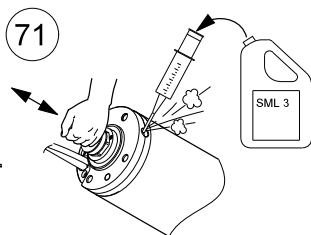
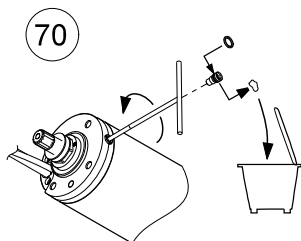



**Argentina**

Bombas GRUNDFOS de Argentina S.A.  
Phone: +54-3327 414 444  
Telefax: +54-3327 411 111

**Australia**

GRUNDFOS Pumps Pty. Ltd.  
Phone: +61-8-8461-4611  
Telefax: +61-8-8340 0155

**Austria**

GRUNDFOS Pumpen Vertrieb Ges.m.b.H.  
Tel.: +43-6246-883-0  
Telefax: +43-6246-883-30

**Belgium**

N.V. GRUNDFOS Bellux S.A.  
Tél.: +32-3-870 7300  
Télécopie: +32-3-870 7301

**Belorussia**

Представительство ГРУНДФОС в Минске  
Тел.: (37517) 233 97 65  
Факс: (37517) 233 97 69

**Bosnia/Herzegovina**

GRUNDFOS Sarajevo  
Phone: +387 33 713 290  
Telefax: +387 33 659 079  
e-mail: grundfos@bih.net.ba

**Brazil**

Mark GRUNDFOS Ltda.  
Phone: +55-11 4393 5533  
Telefax: +55-11 4343 5015

**Bulgaria**

GRUNDFOS Pumpen Vertrieb  
Phone: +359 2963 3820,  
2963 5653  
Telefax: +359 2963 1305

**Canada**

GRUNDFOS Canada Inc.  
Phone: +1-905 829 9533  
Telefax: +1-905 829 9512

**China**

GRUNDFOS Pumps (Shanghai) Co. Ltd.  
Phone: +86-021-612 252 22  
Telefax: +86-021-612 253 33

**Croatia**

GRUNDFOS CROATIA d.o.o.  
Phone: +385 1 6595 400  
Telefax: +385 1 6595 499

**Czech Republic**

GRUNDFOS s.r.o.  
Phone: +420-585-716 111  
Telefax: +420-585-716 299

**Denmark**

GRUNDFOS DK A/S  
Tlf.: +45-87 50 50 50  
E-mail:  
info\_GDK@grundfos.com  
www.grundfos.com/DK

**Estonia**

GRUNDFOS Pumps Eesti OÜ  
Tel: + 372 606 1690  
Fax: + 372 606 1691

**Finland**

OY GRUNDFOS Pumput AB  
Phone: +358-3066 5650  
Telefax: +358-3066 56550

**France**

Pompes GRUNDFOS Distribution S.A.  
Tél.: +33-4 74 82 15 15  
Télécopie: +33-4 74 94 10 51

**Germany**

GRUNDFOS GMBH  
Tel.: +49-(0) 211 929 69-0  
e-mail:  
infoservice@grundfos.de  
Service in Deutschland:  
e-mail:  
kundendienst@grundfos.de

**Greece**

GRUNDFOS Hellas A.E.B.E.  
Phone: +0030-210-66 83 400  
Telefax: +0030-210-66 46 273

**Hong Kong**

GRUNDFOS Pumps (Hong Kong) Ltd.  
Phone: +852-27861706/  
27861741  
Telefax: +852-27858664

**Hungary**

GRUNDFOS Hungária Kft.  
Phone: +36-23 511 110  
Telefax: +36-23 511 111

**India**

GRUNDFOS Pumps India Private Limited  
Phone: +91-44 2496 6800

**Indonesia**

PT GRUNDFOS Pompa  
Phone: +62-21-460 6909  
Telefax: +62-21-460 6910/  
460 6901

**Ireland**

GRUNDFOS (Ireland) Ltd.  
Phone: +353-1-4089 800  
Telefax: +353-1-4089 830

**Italy**

GRUNDFOS Pompe Italia S.r.l.  
Tel.: +39-02-95838112  
Telefax: +39-02-95309290/  
95838461

**Japan**

GRUNDFOS Pumps K.K.  
Phone: +81-35-448 1391  
Telefax: +81-35-448 9619

**Korea**

GRUNDFOS Pumps Korea Ltd.  
Phone: +82-2-5317 600  
Telefax: +82-2-5633 725

**Latvia**

SIA GRUNDFOS Pumps Latvia  
Tālr.: + 371 714 9640, 7 149 641  
Fakss: + 371 914 9646

**Lithuania**

GRUNDFOS Pumps UAB  
Tel: + 370 52 395 430  
Fax: + 370 52 395 431

**Malaysia**

GRUNDFOS Pumps Sdn. Bhd.  
Phone: +60-3-5569 2922  
Telefax: +60-3-5569 2866

**México**

Bombas GRUNDFOS de México S.A. de C.V.  
Phone: +52-81-8144 4000  
Telefax: +52-81-8144 4010

**Netherlands**

GRUNDFOS Netherlands  
Tel.: +31-88-478 6336  
Telefax: +31-88-478 6332

**New Zealand**

GRUNDFOS Pumps NZ Ltd.  
Phone: +64-9-415 3240  
Telefax: +64-9-415 3250

**Norway**

GRUNDFOS Pumper A/S  
Tlf.: +47-22 90 47 00  
Telefax: +47-22 32 21 50

**Poland**

GRUNDFOS Pompy Sp. z o.o.  
Tel: (+48-61) 650 13 00  
Fax: (+48-61) 650 13 50

**Portugal**

Bombas GRUNDFOS Portugal, S.A.  
Tel.: +351-21-440 76 00  
Telefax: +351-21-440 76 90

**România**

GRUNDFOS Pompe România SRL  
Phone: +40 21 200 4100  
E-mail: romania@grundfos.ro

**Russia**

ООО Грундфос  
Тел. (+7) 495 737 30 00, 564 88 00  
E-mail:  
grundfos.moscow@grundfos.com

**Serbia**

GRUNDFOS Predstavništvo Beograd  
Phone: +381 11 26 47 877,  
11 26 47 496  
Telefax: +381 11 26 48 340

**Singapore**

GRUNDFOS (Singapore) Pte. Ltd.  
Phone: +65-6865 1222  
Telefax: +65-6861 8402

**Slovenia**

GRUNDFOS PUMPEN VERTRIEB Ges.m.b.H.,  
Phone: +386 1 568 0610  
Telefax: +386 1 568 0619

**Spain**

Bombas GRUNDFOS España S.A.  
Tel.: +34-91-848 8800  
Telefax: +34-91-628 0465

**Sweden**

GRUNDFOS AB  
Tel.: +46(0)771-32 23 00  
Telefax: +46(0)31-331 94 60

**Switzerland**

GRUNDFOS Pumpen AG  
Tel.: +41-1-806 8111  
Telefax: +41-1-806 8115

**Taiwan**

GRUNDFOS Pumps (Taiwan) Ltd.  
Phone: +886-4-2305 0868  
Telefax: +886-4-2305 0878

**Thailand**

GRUNDFOS (Thailand) Ltd.  
Phone: +66-2-725 8999  
Telefax: +66-2-725 8998

**Turkey**

TOB ГРУНДФОС POMPA San. ve Tic. Ltd. Sti.  
Phone: +90 - 262-679 7979  
Telefax: +90 - 262-679 7905  
E-mail: satis@grundfos.com

**Ukraine**

ТОВ ГРУНДФОС УКРАЇНА  
Тел.: (+38 044) 390 40 50  
Факс.: (+38 044) 390 40 59

**United Arab Emirates**

GRUNDFOS Gulf Distribution  
Phone: +971-4- 8815 166  
Telefax: +971-4-8815 136

**United Kingdom**

GRUNDFOS Pumps Ltd.  
Phone: +44-1525-850000  
Telefax: +44-1525-850011

**U.S.A.**

GRUNDFOS Pumps Corporation  
Phone: +1-913-227-3400  
Telefax: +1-913-227-3500

**Usbekistan**

Представительство ГРУНДФОС в Ташкенте  
Телефон: (3712) 55-68-15  
Факс: (3712) 53-36-35

Being responsible is our foundation  
Thinking ahead makes it possible  
Innovation is the essence

---

<b>96163822</b> 1209	<b>126</b>
Repl. 96163822 0909	